



GMK3050

# All Terrain Hydraulic Crane



# Dimensions

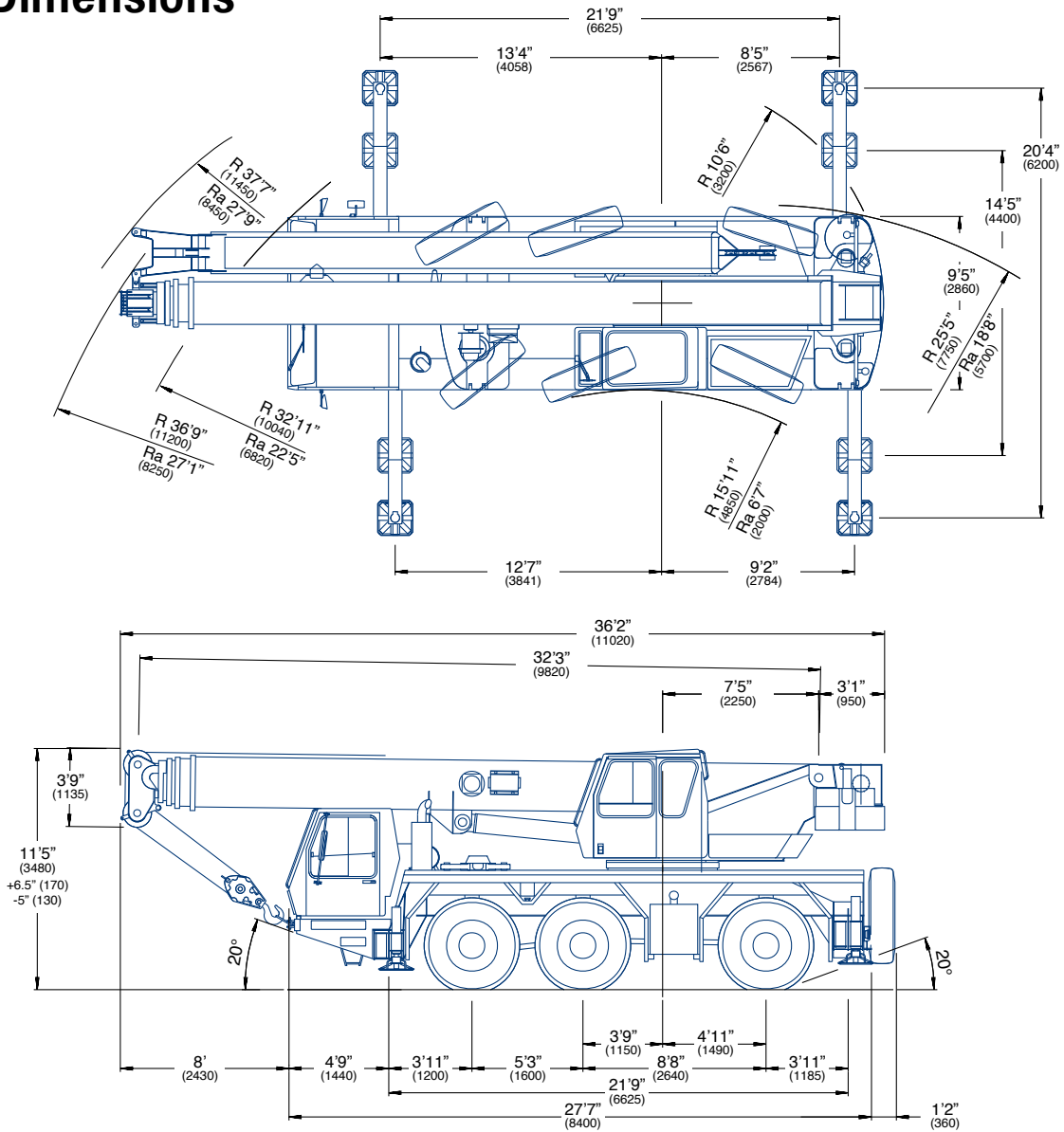

Note: ( ) Reference dimensions in mm

BASIC WEIGHTS (LBS.)	Axles 1 & 2	Axle 3	Total
With Mercedes Power, 6x4x6, 20.5 R25 Tires, 12,500 lbs Fixed Counterweight Hydraulic Oil Cooler, Brackets for Lattice Extension	45,632	28,548	74,180
<b>Additions:</b>			
Outrigger Pads	227	104	331
Auxiliary Hoist	-(712)	1,947	1,235
Lattice Extension - 28/49 ft	2,895	-(955)	1,940
Rooster Sheave	293	-(181)	112
6 x 6 Drive	962	-(168)	794
Electric Driveline Retarder	44	375	419
16.00 R25 Tires in lieu	-(370)	-(186)	-(556)
14.00 R25 Tires in lieu	-(899)	-(450)	-(1,349)
Spare Tire - 14.00 R25 (with stowage bracket)	-(282)	866	584
Spare Tire - 16.00 R25 (with stowage bracket)	-(352)	1,069	717
Spare Tire - 20.5 R25 (with stowage bracket)	-(408)	1,217	809

# Working range



32 - 125 ft.  
(9.8 - 38.1 m)



28 - 49 ft.  
(8.7 - 15 m)



23,100 lbs.  
(10,500 kg)

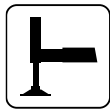

100%



360°

FEET

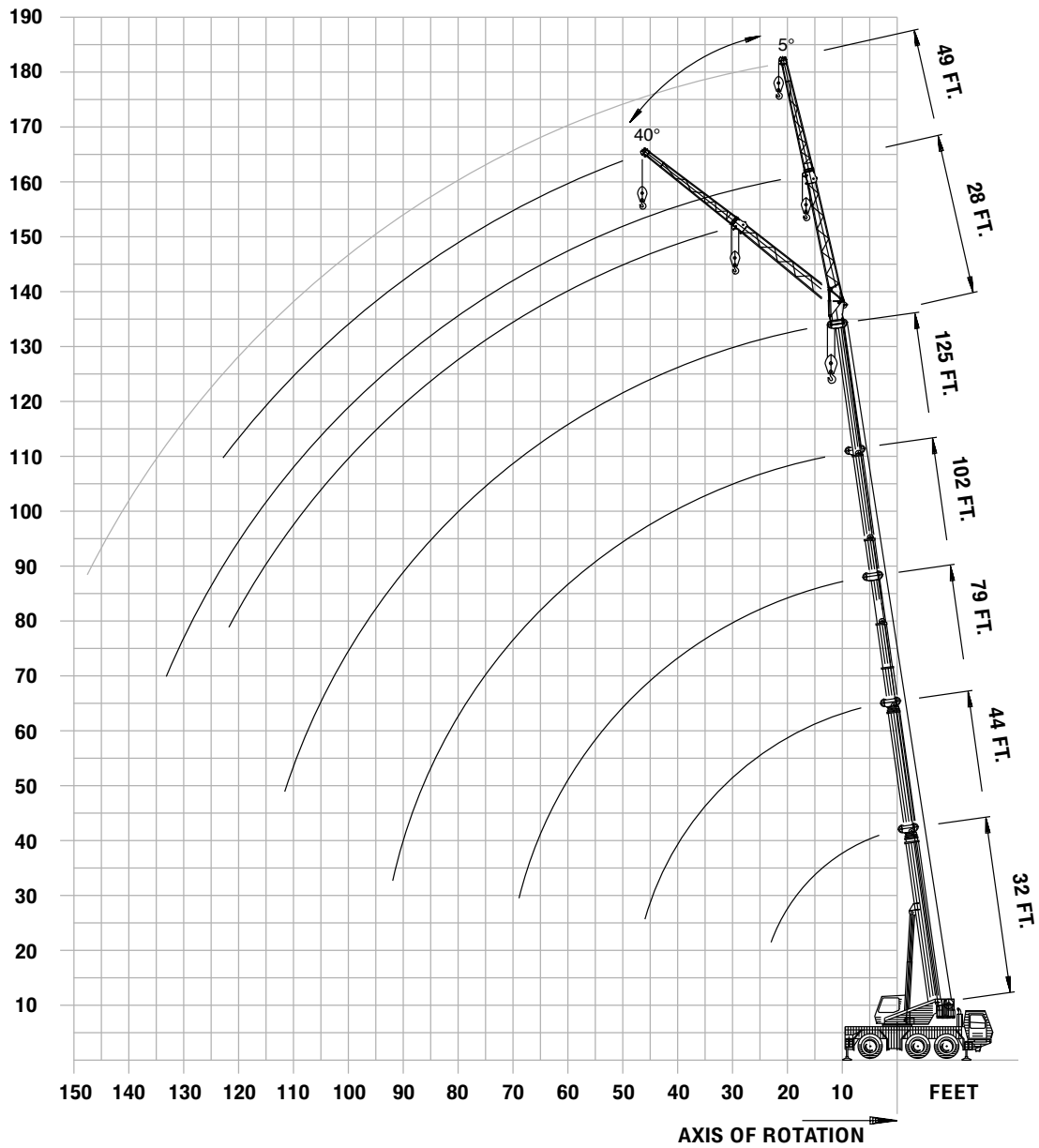

# Superstructure specifications

## Boom

32 ft. - 125 ft. (9.8 m - 38.1 m) five section, full-power boom. Maximum tip height: 133 ft. (40.5 m).

## Boom Elevation

Single lift cylinder with safety valve provides boom angle from -3° to +82°.

## Lattice Extension

28 ft. - 49 ft. (8.7 m - 15 m) lattice swingaway extension. Hydraulic offset / luffing capability 5° - 40°.

## Load Moment & Anti-Two Block System

Load moment and anti-two block system with audio/visual warning and control lever lockout provides electronic display of boom angle, length, radius, tip height, relative load moment, maximum permissible load, load indication and warning of impending two-block condition.

## Cab

Full vision aluminum cab, safety glass windows and adjustable operator's seat with hydraulic suspension. Other features include engine independent heater, arm-rest integrated crane controls, and ergonomically arranged instrumentation for carrier and superstructure.

## Swing

Axial piston motor with planetary gear. Holding and service brake. Swing speed variable from 0 - 2.5 RPM.

## Counterweight

23,150 lbs. (10 500 kg) consisting of various sections with hydraulic installation/removal system controlled from the cab.

## Hydraulic system

Two separate open pump circuits with one axial piston variable displacement pump (load sensing) and one gear pump for swing. Thermostatically controlled oil cooler.

159 gallon (600 L) reservoir capacity.

All crane movements infinitely variable by hydraulic pilot circuit control levers with automatic reset to zero.

## HOIST SPECIFICATIONS

### Main Hoist

Axial piston variable displacement motor with planetary gear and multiple disc brake. Rope drum with special grooving. "Thumb-thumper" hoist drum rotation indicator alerts operator of hoist movement.

Single line pull: 9,900 lbs.  
(44 kN)

Single line speed: 394 ft./min.  
(120m/min)

Rope diameter: 16 mm

Rope length: 492 ft.  
(150 m)

### Auxiliary Hoist

Axial piston variable displacement motor with planetary gear and multiple disc brake. Rope drum with special grooving. "Thumb-thumper" hoist drum rotation indicator alerts operator of hoist movement.

Single line pull: 9,900 lbs.  
(44 kN)

Single line speed: 394 ft./min.  
(120m/min)

Rope diameter: 16 mm

Rope length: 492 ft.  
(150 m)

### \* Optional equipment

- \*Second spotlight
- \*Stereo/cassette player
- \*Air Conditioning

\*Denotes optional equipment

# Carrier specifications

## Chassis

Box-type, torsion resistant frame is fabricated from high-strength steel.

## Outrigger System

Four hydraulically telescoping beam outriggers with vertical cylinders and outrigger pads. Outriggers can be set in 2 positions:

Fully extended (100%) - 20' 4" (6.2m)

Partially extended (50%) - 14' 5" (4.4m)

Independent horizontal and vertical movement control on each side of the carrier and from the crane operator's cab. Crane level indicators at each control station.

## Engine

Mercedes-Benz OM501LA, diesel, 6 cylinders, water cooled, turbo charged and aftercooled, 349 HP (260 kW) at 1800 rpm. Max. torque: 1,276 ft./lbs. (1730 Nm) at 1080 rpm.

Engine emission: EURO II/EUROMOT/EPA/CARB (off highway).

Fuel Tank Capacity: 95 gallons. (360 L).

## Transmission

Allison automatic MD 3066 P, 6 forward and 1 reverse speed. Transfer case with 2 speeds, inter-axle differential lock and integrated central power take-off for the second axle line.

## Drive/Steer

6 x 4 x 6

## Axles

1st axle line - steer.

2nd axle line - drive/steer.

3rd axle line - drive/steer.

Drive axles with planetary hub reduction and center mounted gearing

## Suspension

GMK3050 features the Grove exclusive MEGATRAK† suspension. This revolutionary design features an independent hydroneumatic system with hydraulic lockout acting on all wheels. The suspension can be raised 6-1/2" (170 mm) or lowered 5" (130 mm) both longitudinally and transversely and features an automatic leveling system for on-highway travel.

## Tires

6 tires, 20.5 R25.

## Steering

Dual circuit, Servocom power steering with emergency steering pump. Axles 1 and 2 steer on highway. Separate steering of the 3rd axle line for all-wheel steering and crab-steer is controlled by an electric rocker switch.

## Brakes

Service brake: pneumatic dual circuit acting on all wheels, air dryer. Permanent brake: exhaust brake and constant throttle brake is standard.

Parking brake: pneumatically operated spring-loaded, acting on 2nd and 3rd axle lines.

## Cab

Aluminum, two-man design, safety glass, driver's seat with hydraulic suspension, engine-dependent hot water heater. Complete instrumentation and driving controls. Cab can be tilted forward by 60° for easy access to engine, transmission, hydraulic pumps, heater and batteries.

## Electrical system

24 V system with three-phase alternator 28 V/100 A, 2 batteries 12 V/170 Ah.

## Maximum Speed

53 mph (85 km/h) with 20.5 R25 Tires

## Gradeability (theoretical)

52% with 20.5 R25 Tires

## Miscellaneous standard equipment

Additional hydraulic oil cooler; spare tire and wheel - 20.5 R25 with carry bracket; flashing amber warning light on carrier cab; working light; tool kit; fire extinguisher; rooster sheave; radio cassette in carrier cab.

## \* Optional equipment

\* 6 x 6 x 6

\* Electric driveline retarder

\* 16.00 R25 tires (vehicle width 9 ft. [2.75 m])

\* 14.00 R25 tires (vehicle width 8 ft. 2 in. [2.50 m])





\* Engine-independent hot water heater, with engine pre-heater

\* Trailing boom kit (less dolly)

\* Air conditioning

\* Denotes optional equipment

† "G MEGATRAK" (and design) is a trademark of Grove U.S. L.L.C.



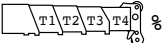

  
 32 - 125 ft. (9.8 - 38.1 m)      23,150 lbs. (10,500 kg)      100% 20'4" Spread      360°



Feet	Pounds								
	32	44	55	67	79	90	102	113	125
10	*110,000								
10	108,000	67,000	67,000	38,800	38,800	36,400			
15	81,000	61,000	67,000	38,800	38,800	36,400	26,600	20,600	
20	61,000	50,000	56,000	38,800	38,800	36,400	26,600	20,600	17,400
25		42,000	43,800	38,800	37,600	34,600	26,400	20,600	17,400
30		35,200	36,400	33,000	32,800	30,000	24,600	20,400	17,400
35			28,200	26,200	26,200	26,000	22,400	20,200	17,400
40			22,600	23,200	21,000	21,400	20,400	20,000	17,200
45			18,600	19,200	17,000	17,600	17,800	17,800	16,800
50				16,200	14,600	16,000	15,000	15,200	15,200
55					13,600	14,400	13,400	13,000	13,000
60					12,000	12,400	12,400	11,000	11,200
65					10,400	10,600	10,800	9,200	9,600
70						9,200	9,400	7,800	8,200
75						8,000	8,200	6,600	7,000
80							7,200	5,600	6,000
85							6,400	4,800	5,000
90							5,600	4,000	4,200
95								3,400	3,600
100									3,000
105									2,400
110									2,000



T1	0	50/0	100/0	100/0	100/0	100/0	100/0	100	100
T2	0	0/17	0/33	17/50	33/67	50/83	67/100	83	100
T3	0	0/17	0/33	17/50	33/67	50/83	67/100	83	100
T4	0	0/17	0/33	17/50	33/67	50/83	67/100	83	100

\* Over rear only.  
 Lifting capacities greater than 97,000 lbs (44,000 kg) require additional equipment.  
 NOTE: Above loadchart also available with 50% outriggers.



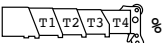

  
 32 - 125 ft. (9.8 - 38.1 m)      15,400 lbs. (7,000 kg)      100% 20'4" Spread      360°

Feet	Pounds								
	32	44	55	67	79	90	102	113	125
10	*110,000								
10	108,000	67,000	67,000	38,800	38,800	36,400			
15	81,000	61,000	67,000	38,800	38,800	36,400	26,600	20,600	
20	58,000	50,000	52,000	38,800	38,800	36,400	26,600	20,600	17,400
25		38,800	38,800	36,400	35,800	34,600	26,400	20,600	17,400
30		30,000	31,200	29,200	27,400	27,000	24,600	20,400	17,400
35			24,000	24,600	21,600	21,600	21,400	20,200	17,400
40			19,200	19,600	17,400	19,400	17,600	17,200	17,000
45			15,400	16,000	16,000	16,800	16,000	14,400	14,200
50				13,200	13,600	14,000	14,200	12,000	12,000
55					11,400	11,800	12,000	10,200	10,200
60					9,600	10,000	10,200	8,400	8,600
65					8,000	8,400	8,600	7,000	7,200
70						7,200	7,400	5,800	6,000
75						6,200	6,400	4,800	5,000
80							5,400	3,800	4,200
85							4,600	3,200	3,400
90							4,000	2,400	2,800
95								1,800	2,200
100									1,600



T1	0	50/0	100/0	100/0	100/0	100/0	100/0	100	100
T2	0	0/17	0/33	17/50	33/67	50/83	67/100	83	100
T3	0	0/17	0/33	17/50	33/67	50/83	67/100	83	100
T4	0	0/17	0/33	17/50	33/67	50/83	67/100	83	100

\* Over rear only.  
 Lifting capacities greater than 97,000 lbs (44,000 kg) require additional equipment.  
 NOTE: Above loadchart also available with 50% outriggers.

  
32 - 125 ft.  
(9.8 - 38.1 m)

  
12,500 lbs.  
(5,700 kg)

  
100%  
20'4" Spread

  
360°

Feet	Pounds									
	32	44	55	67	79	90	102	113	125	
10	*110,000									
10	108,000	67,000	67,000	38,800	38,800	36,400				
15	80,000	61,000	67,000	38,800	38,800	36,400	26,600	20,600		
20	57,000	50,000	48,000	38,800	38,800	36,400	26,600	20,600	17,400	
25		38,800	38,800	34,000	33,400	32,600	26,400	20,600	17,400	
30		28,200	29,200	29,200	25,400	25,000	24,600	20,400	17,400	
35			22,400	23,000	19,800	21,200	19,800	19,400	17,400	
40			17,600	18,200	17,400	18,800	17,600	15,800	15,600	
45			14,200	14,800	15,200	15,400	15,600	13,000	13,000	
50				12,000	12,400	12,800	13,000	10,800	10,800	
55					10,400	10,600	10,800	9,000	9,000	
60					8,600	9,000	9,200	7,600	7,600	
65					7,200	7,600	7,800	6,200	6,400	
70						6,400	6,600	5,000	5,400	
75						5,400	5,600	4,000	4,400	
80							4,800	3,200	3,600	
85							4,000	2,600	2,800	
90							3,400	1,800	2,200	
95									1,600	

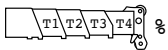

	T1	T2	T3	T4					
T1	0	50/0	100/0	100/0	100/0	100/0	100/0	100	100
T2	0	0/17	0/33	17/50	33/67	50/83	67/100	83	100
T3	0	0/17	0/33	17/50	33/67	50/83	67/100	83	100
T4	0	0/17	0/33	17/50	33/67	50/83	67/100	83	100

\* Over rear only.  
Lifting capacities greater than 97,000 lbs (44,000 kg) require additional equipment.  
NOTE: Above loadchart also available with 50% outriggers.

**FIXED LATTICE EXTENSION**

 102 - 125 ft. (31 - 38.1 m)  
 28 - 49 ft. (8.7 - 15 m)  
 23,100 lbs. (10,500 kg)  
 100% 20'4" Spread  
 360°

		102 FT MAIN BOOM						125 FT MAIN BOOM					
		28 FT		49 FT		49 FT		28 FT		49 FT		49 FT	
Feet		5°	20°	40°	5°	20°	40°	5°	20°	40°	5°	20°	40°
20		10,000											
25		10,600			6,000								
30		10,600			6,600			8,400					
35		10,600	10,200	8,400	6,600			8,400			5,400		
40		10,600	9,800	8,200	6,400	5,800		8,400	8,400		5,400		
45		10,600	9,400	8,000	6,400	5,600		8,400	8,400	7,800	5,400		
50		10,200	9,000	7,800	6,400	5,400	4,400	8,400	8,400	7,800	5,400	5,200	
55		9,600	8,800	7,600	6,200	5,200	4,200	8,400	8,400	7,600	5,400	5,200	
60		9,200	8,400	7,400	5,800	5,000	4,200	8,400	8,400	7,400	5,400	5,000	4,200
65		8,600	8,200	7,400	5,600	4,800	4,000	8,400	8,400	7,400	5,400	4,800	4,000
70		8,200	7,800	7,200	5,400	4,600	4,000	8,400	8,200	7,200	5,400	4,600	4,000
75		7,800	7,600	7,200	5,200	4,400	3,800	7,400	7,800	7,200	5,400	4,600	4,000
80		7,400	7,200	7,000	5,000	4,400	3,800	6,400	6,800	7,200	5,200	4,400	3,800
85		6,800	7,000	6,800	4,800	4,200	3,800	5,600	5,800	6,200	5,000	4,400	3,800
90		6,000	6,200	6,400	4,600	4,200	3,800	4,800	5,000	5,200	4,800	4,200	3,800
95		5,400	5,400	5,600	4,600	4,000	3,600	4,000	4,200	4,400	4,800	4,200	3,600
100		4,600	4,800		4,200	4,000	3,600	3,400	3,600	3,800	4,800	4,000	3,600
105		4,000	4,200		4,200	3,800	3,600	2,800	3,000	3,200	3,600	4,000	3,600
110		3,600	3,600		4,000	3,800	3,600	2,200	2,400	2,600	3,000	3,400	3,600
115		3,200			3,800	3,600	3,600	1,800	2,000		2,600	3,000	3,200
120					3,400	3,600					2,200	2,400	2,800
125					3,000	3,200						2,000	2,200
130					2,600	2,600						1,600	1,800
135					2,200								

T	102 FT MAIN BOOM	125 FT MAIN BOOM
T1	0/100	100
T2	100/67	100
T3	100/67	100
T4	100/67	100

**LATTICE EXTENSION (LUFFING)**

 102 - 125 ft. (31 - 38.1 m)  
 28 - 49 ft. (8.7 - 15 m)  
 23,100 lbs. (10,500 kg)  
 100% 20'4" Spread  
 360°

		102 FT MAIN BOOM				125 FT MAIN BOOM			
		28 FT		49 FT		28 FT		49 FT	
Feet		*5° - 20°	*20° - 40°	*5° - 20°	*20° - 40°	*5° - 20°	*20° - 40°	*5° - 20°	*20° - 40°
30		5,600							
35		5,200	4,200						
40		5,000	4,000	2,800		5,200			
45		4,600	4,000	2,600		5,000	4,000		
50		4,400	3,800	2,400	2,000	4,800	4,000	2,600	
55		4,200	3,800	2,400	2,000	4,600	3,800	2,600	
60		4,000	3,600	2,200	1,800	4,400	3,800	2,400	2,000
65		3,800	3,600	2,000	1,800	4,200	3,800	2,200	1,800
70		3,800	3,600	2,000	1,800	4,000	3,600	2,200	1,800
75		3,600	3,400	1,800	1,600	4,000	3,600	2,000	1,800
80		3,400	3,400	1,800	1,600	3,800	3,600	2,000	1,800
85		3,400	3,400	1,800	1,600	3,600	3,400	1,800	1,600
90		3,200	3,200	1,600	1,600	3,600	3,400	1,800	1,600
95		3,200	3,200	1,600	1,600	3,400	3,400	1,800	1,600
100		3,000		1,600	1,400	3,000	3,200	1,600	1,600
105		3,000		1,400	1,400	2,600	2,800	1,600	1,600
110		2,800		1,400	1,400	2,000	2,200	1,600	1,400
115				1,400	1,400	1,600		1,600	1,400
120								1,400	1,400
125									1,400
130									1,400

T	102 FT MAIN BOOM	125 FT MAIN BOOM
T1	0/100	100
T2	100/67	100
T3	100/67	100
T4	100/67	100

\* Luffing under load.



**FIXED LATTICE EXTENSION**

102 - 125 ft. (31 - 38.1 m)    
 28 - 49 ft. (8.7 - 15 m)    
 15,400 lbs. (7,000 kg)    
 100% 20'4" Spread    
 360°

		102 FT MAIN BOOM						125 FT MAIN BOOM					
		28 FT		49 FT		49 FT		28 FT		49 FT		49 FT	
Feet		5°	20°	40°	5°	20°	40°	5°	20°	40°	5°	20°	40°
20		10,000											
25		10,600			6,000								
30		10,600			6,600			8,400					
35		10,600	10,200	8,400	6,600			8,400			5,400		
40		10,600	9,800	8,200	6,400	5,800		8,400	8,400		5,400		
45		10,600	9,400	8,000	6,400	5,600		8,400	8,400	7,800	5,400		
50		10,200	9,000	7,800	6,400	5,400	4,400	8,400	8,400	7,800	5,400	5,200	
55		9,600	8,800	7,600	6,200	5,200	4,200	8,400	8,400	7,600	5,400	5,200	
60		9,200	8,400	7,400	5,800	5,000	4,200	8,400	8,400	7,400	5,400	5,000	4,200
65		8,600	8,200	7,400	5,600	4,800	4,000	7,400	8,000	7,400	5,400	4,800	4,000
70		8,000	7,800	7,200	5,400	4,600	4,000	6,200	6,800	7,200	5,400	4,600	4,000
75		7,000	7,200	7,200	5,200	4,400	3,800	5,400	5,800	6,200	5,400	4,600	4,000
80		6,000	6,200	6,600	5,000	4,400	3,800	4,400	4,800	5,200	5,000	4,400	3,800
85		5,200	5,400	5,600	4,800	4,200	3,800	3,800	4,200	4,400	4,400	4,400	3,800
90		4,400	4,600	4,800	4,600	4,200	3,800	3,000	3,400	3,800	3,800	4,200	3,800
95		3,800	4,000	4,200	4,400	4,000	3,600	2,600	2,800	3,000	3,200	3,800	3,600
100		3,200	3,400		4,000	3,800	3,600	2,000	2,200	2,400	2,600	3,200	3,600
105		2,800	2,800		3,400	3,800	3,600	1,400	1,800	1,800	2,200	2,600	3,200
110		2,400	2,400		3,000	3,200	3,600			1,400	1,800	2,200	2,600
115		2,000			2,600	2,800	3,000				1,400	1,800	2,000
120					2,200	2,400						1,400	1,600
125					1,800	2,000							
130					1,600	1,600							

T1	0/100	100
T2	100/67	100
T3	100/67	100
T4	100/67	100

**LATTICE EXTENSION (LUFFING)**

102 - 125 ft. (31 - 38.1 m)    
 28 - 49 ft. (8.7 - 15 m)    
 15,400 lbs. (7,000 kg)    
 100% 20'4" Spread    
 360°

		102 FT MAIN BOOM				125 FT MAIN BOOM			
		28 FT		49 FT		28 FT		49 FT	
Feet		*5° - 20°	*20° - 40°	*5° - 20°	*20° - 40°	*5° - 20°	*20° - 40°	*5° - 20°	*20° - 40°
30		5,600							
35		5,200	4,200						
40		5,000	4,000	2,800		5,200			
45		4,600	4,000	2,600		5,000	4,000		
50		4,400	3,800	2,400	2,000	4,800	4,000		
55		4,200	3,800	2,400	2,000	4,600	3,800	2,600	
60		4,000	3,600	2,200	1,800	4,400	3,800	2,400	2,000
65		3,800	3,600	2,000	1,800	4,200	3,800	2,200	1,800
70		3,800	3,600	2,000	1,800	4,000	3,600	2,200	1,800
75		3,600	3,400	1,800	1,600	4,000	3,600	2,000	1,800
80		3,400	3,400	1,800	1,600	3,800	3,600	2,000	1,800
85		3,400	3,400	1,800	1,600	3,400	3,400	1,800	1,600
90		3,200	3,200	1,600	1,600	2,800	3,200	1,800	1,600
95		3,200	3,200	1,600	1,600	2,200	2,600	1,800	1,600
100		3,000		1,600	1,400	1,800	2,000	1,600	1,600
105		2,600		1,400	1,400	1,400	1,600	1,600	1,600
110		2,200		1,400	1,400			1,600	1,400
115				1,400	1,400				1,400

T1	0/100	100
T2	100/67	100
T3	100/67	100
T4	100/67	100

\* Luffing under load.

**FIXED LATTICE EXTENSION**

 102 - 125 ft. (31 - 38.1 m)  
 28 - 49 ft. (8.7 - 15 m)  
 12,500 lbs. (5,700 kg)  
 100% 20'4" Spread  
 360°

		102 FT MAIN BOOM						125 FT MAIN BOOM					
		28 FT		49 FT		49 FT		28 FT		49 FT		49 FT	
Feet		5°	20°	40°	5°	20°	40°	5°	20°	40°	5°	20°	40°
20		10,000											
25		10,600			6,000								
30		10,600			6,600			8,400					
35		10,600	10,200	8,400	6,600			8,400			5,400		
40		10,600	9,800	8,200	6,400	5,800		8,400	8,400		5,400		
45		10,600	9,400	8,000	6,400	5,600		8,400	8,400	7,800	5,400		
50		10,200	9,000	7,800	6,400	5,400	4,400	8,400	8,400	7,800	5,400	5,200	
55		9,600	8,800	7,600	6,200	5,200	4,200	8,400	8,400	7,600	5,400	5,200	
60		9,200	8,400	7,400	5,800	5,000	4,200	7,600	8,200	7,400	5,400	5,000	4,200
65		8,400	8,200	7,400	5,600	4,800	4,000	6,400	7,000	7,400	5,400	4,800	4,000
70		7,200	7,600	7,200	5,400	4,600	4,000	5,400	6,000	6,400	5,400	4,600	4,000
75		6,200	6,600	6,800	5,200	4,400	3,800	4,600	5,000	5,400	5,200	4,600	4,000
80		5,400	5,600	5,800	5,000	4,400	3,800	3,800	4,200	4,600	4,400	4,400	3,800
85		4,600	4,800	5,000	4,800	4,200	3,800	3,000	3,400	3,800	3,600	4,400	3,800
90		3,800	4,000	4,200	4,600	4,000	3,800	2,400	2,800	3,000	3,000	3,800	3,800
95		3,200	3,400	3,600	4,000	4,000	3,600	1,800	2,200	2,400	2,600	3,200	3,600
100		2,800	3,000		3,400	3,800	3,600	1,400	1,600	1,800	2,000	2,600	3,200
105		2,200	2,400		3,000	3,200	3,600			1,400	1,600	2,000	2,600
110		1,800	2,000		2,600	2,800	3,000					1,600	2,000
115		1,400			2,200	2,400	2,600						1,600
120					1,800	2,000							
125					1,400	1,600							

	T1	T2	T3	T4
	0/100			
		100/67		
		100/67		
		100/67		

 102 - 125 ft. (31 - 38.1 m)  
 28 - 49 ft. (8.7 - 15 m)  
 12,500 lbs. (5,700 kg)  
 100% 20'4" Spread  
 360°

**LATTICE EXTENSION (LUFFING)**

		102 FT MAIN BOOM				125 FT MAIN BOOM			
		28 FT		49 FT		28 FT		49 FT	
Feet		*5° - 20°	*20° - 40°	*5° - 20°	*20° - 40°	*5° - 20°	*20° - 40°	*5° - 20°	*20° - 40°
30		5,600							
35		5,200	4,200						
40		5,000	4,000	2,800		5,200			
45		4,600	4,000	2,600		5,000	4,000		
50		4,400	3,800	2,400	2,000	4,800	4,000		
55		4,200	3,800	2,400	2,000	4,600	3,800	2,600	
60		4,000	3,600	2,200	1,800	4,400	3,800	2,400	2,000
65		3,800	3,600	2,000	1,800	4,200	3,800	2,200	1,800
70		3,800	3,600	2,000	1,800	4,000	3,600	2,200	1,800
75		3,600	3,400	1,800	1,600	4,000	3,600	2,000	1,800
80		3,400	3,400	1,800	1,600	3,400	3,600	2,000	1,800
85		3,400	3,400	1,800	1,600	2,800	3,200	1,800	1,600
90		3,200	3,200	1,600	1,600	2,200	2,600	1,800	1,600
95		3,000	3,200	1,600	1,600	1,800	2,000	1,800	1,600
100		2,600		1,600	1,400		1,600	1,600	1,600
105		2,000		1,400	1,400			1,400	1,600
110		1,800		1,400	1,400				1,600
115				1,400	1,400				

  

	T1	T2	T3	T4
	0/100			
		100/67		
		100/67		
		100/67		

\* Luffing under load.

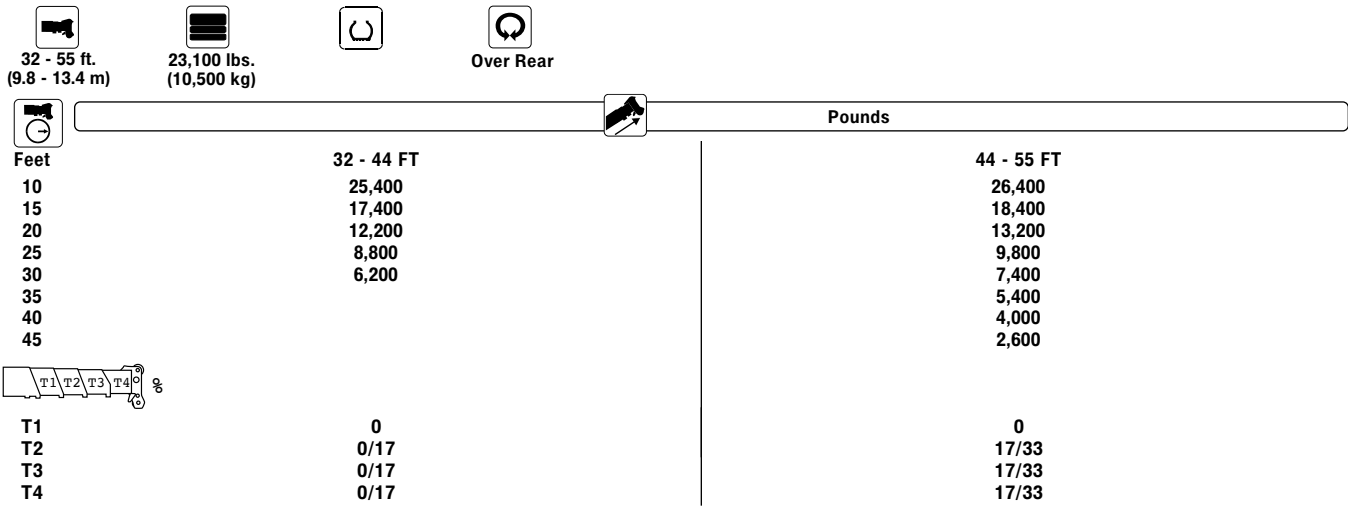

\* Over rear only.

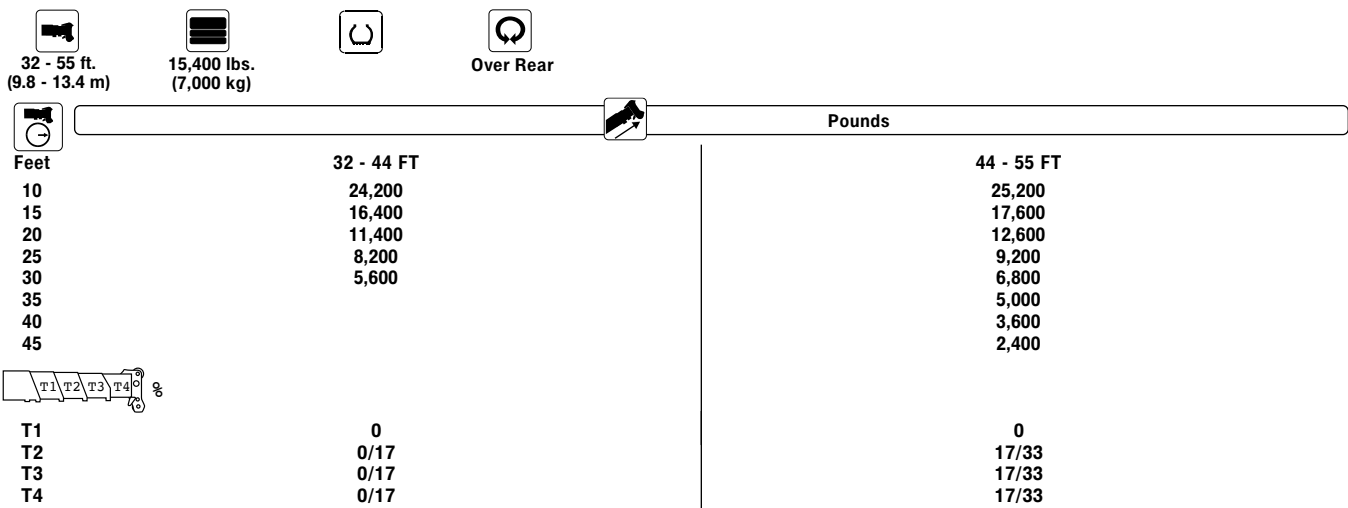

\* Over rear only.

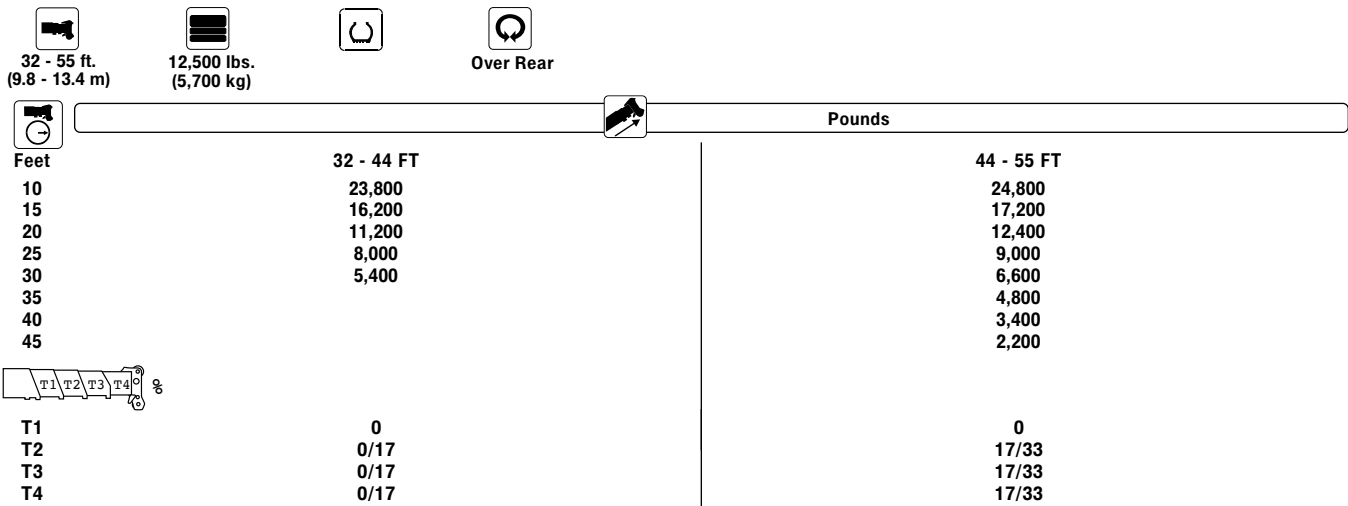

\* Over rear only.

THIS CHART IS ONLY A GUIDE AND SHOULD NOT BE USED TO OPERATE THE CRANE. The individual crane's load chart, operating instructions and other instructional plates must be read and understood prior to operating the crane.

# Rated Lifting Capacities

## IMPORTANT NOTES:

**WARNING: THIS CHART IS ONLY A GUIDE.**  
 The notes below are for illustration only and should not be relied upon to operate the crane. The individual crane's load chart, operating instructions and other instruction plates must be read and understood prior to operating the crane.

1. All rated loads meet ANSI/ASME B30.5, Mobile and Locomotive Cranes. Testing and development were performed to SAEJ1063, Cantilevered Boom Crane Structures - Method of Test and SAEJ765 Crane Stability Test Code.

2. Capacities given do not include the weight of hook blocks, slings, auxiliary lifting equipment and load handling devices. Their weights must be added to the load to be lifted. When more than minimum required reeving is used, the additional rope weight shall be considered part of the load.

3. The machine shall be leveled on a firm supporting surface. Depending on the nature of the supporting surface, it may be necessary to have structural supports under the outrigger floats to spread the load to a larger bearing surface.

4. When either boom length or radius or both are between values listed, the smallest load shown at either the next larger radius or next longer or shorter boom length shall be used.

5. For outrigger operation, outriggers shall be properly extended with tires raised off the ground before operating the boom or lifting loads.

## Symbols Glossary

	Frame		Steering
	Outriggers		Transmission
	Outrigger Controls		Axles
	Engine		Brakes
	Fuel Tank Capacity		Tires
	Electrical System		Suspension
	Drive		Rotation
	Lights		Boom Elevation
	Cab		Swing
	Boom		Counterweight
	Fixed Swingaway		Oil
	Tele-Swingaway		Hydraulic System
	Lattice Extension (Luffing)		Hoist
	Boom Nose		Radius
	Boom Extension		Boom Length
	Speed		Hookblock
	Grade		Gear
	Lattice Extension		Luffing Jib

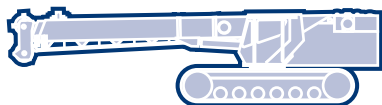
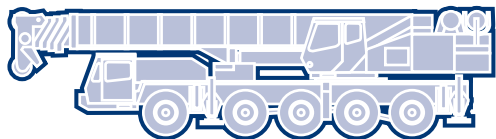

**Grove Worldwide –  
World Headquarters  
Grove U.S. L.L.C.**  
1565 Buchanan Trail East  
P.O. Box 21  
Shady Grove, Pennsylvania 17256, U.S.A.  
Tel: [Int + 1] (717) 597-8121  
Fax: [Int + 1] (717) 597-4062  
Western Hemisphere

**Grove Europe Limited\***  
Sunderland SR4 6TT, England  
Tel: [Int + 44] 191 565-6281  
Fax: [Int + 44] 191 564-0442  
Europe, Africa, Middle East, Asia/Pacific

**Grove Europe Limited\***  
Telford Road, Bicester  
Oxfordshire, OX6 0TZ  
Tel: [Int + 44] 1869 878-890  
Fax: [Int + 44] 1869 878-891  
\*Grove Europe Limited, Registered in England,  
Number 1845128, Registered office, Crown Works,  
Pallion, Sunderland, Tyne & Wear, England SR4 6TT

**Deutsche Grove GmbH  
Sales and Service**  
Helmholtzstrasse 12, Postfach 5026  
D-40750 Langenfeld, Germany  
Tel: [Int + 49] (2173) 8909-0  
Fax: [Int + 49] (2173) 8909-30

**Wilhelmshaven Works**  
Industriegelände West, Postfach 1853  
D-26358 Wilhelmshaven, Germany  
Tel: [Int + 49] (4421) 294-0  
Fax: [Int + 49] (4421) 294-301

**Grove France S.A.**  
16, chaussée Jules-César, 95520 OSNY  
B.P. 203, 95523 CERGY PONTOISE CEDEX  
France  
Tel: [Int + 33] (1) 30313150  
Int: [Int + 33] (1) 30386085

**Grove Asia/Pacific - Regional Office**  
171 Chin Swee Road  
San Centre  
Singapore 0316  
Tel: [Int + 65] 536-6112  
Fax: [Int + 65] 536-6119  
Asia/Pacific, Near East

**Grove China - Representative Office**  
Room 713, Towercrest Plaza  
No. 3 Mai Zi Dian West Road  
Chao Yang District  
Beijing, China 100016  
Tel: [Int + 86] (10) 64 67 16 90  
Fax: [Int + 86] (10) 64 67 16 91

**Grove Product Support**  
Western Hemisphere  
1086 Wayne Avenue  
Chambersburg, Pennsylvania USA  
Tel: [Int + 1] (717) 263-5100  
Fax: [Int + 1] (717) 267-0404

Europe, Africa, Middle East, Asia/Pacific  
Sunderland SR4 6TT, England  
Tel: [Int + 44] 191 565-6281  
Parts Fax: [Int + 44] 191 510-9242  
Service Fax: [Int + 44] 191 510-9560

<http://www.groveworldwide.com>

Constant improvement and engineering progress make it necessary that we reserve the right to make specification, equipment, and price changes without notice. Illustrations shown may include optional equipment and accessories and may not include all standard equipment.

Distributed By:

